

TLC880M

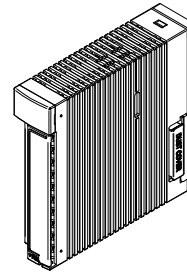

협소공간에서의 설치

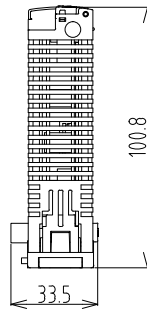
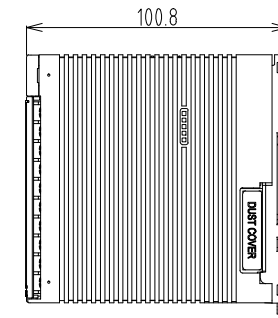
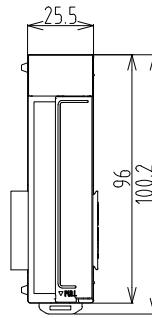
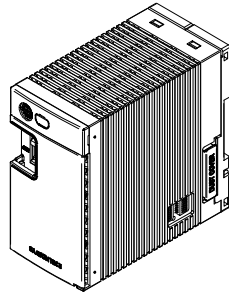
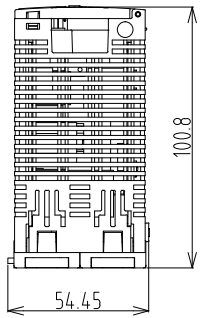
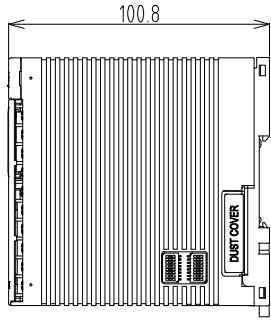
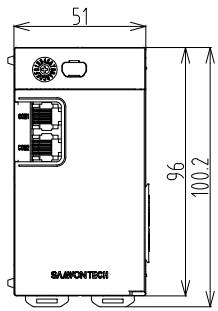
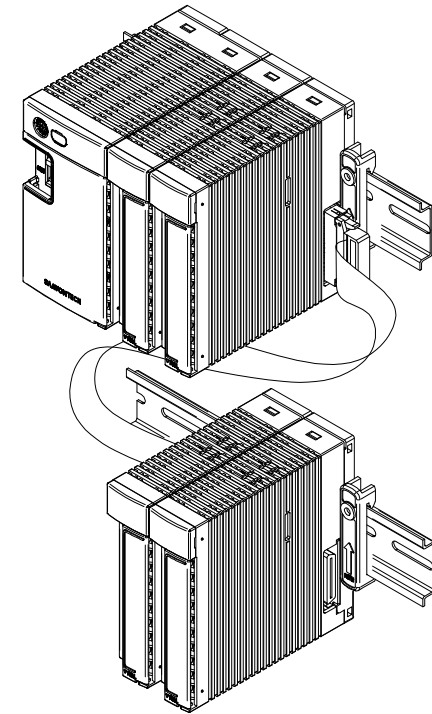

일반적인 경우의 설치

$$51 + (25.5 \times N) + (11.5 \times 2) = K \quad (\text{MAX} = 329)$$

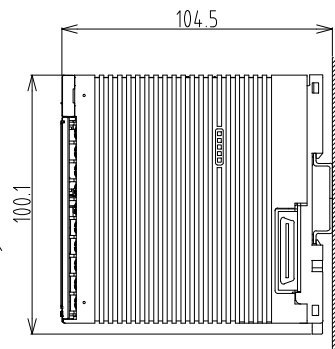
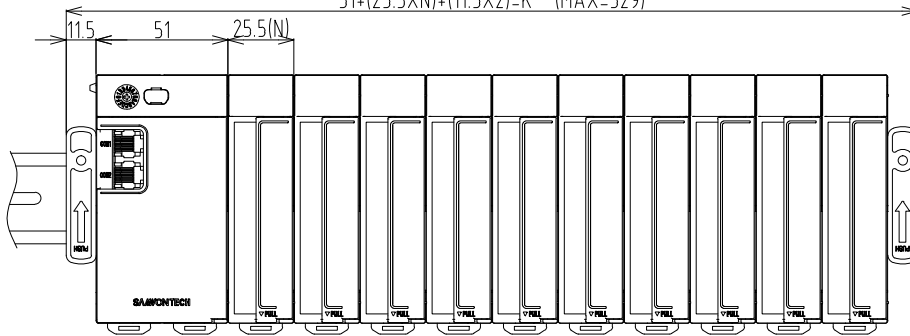

K : 전체길이
N : CU 수량

TITLE

TLC880 외형도

TLC990M

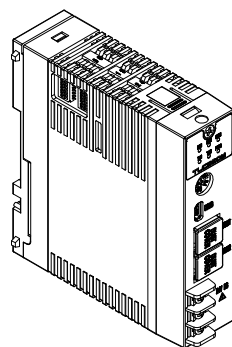
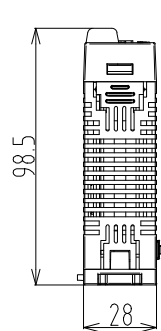
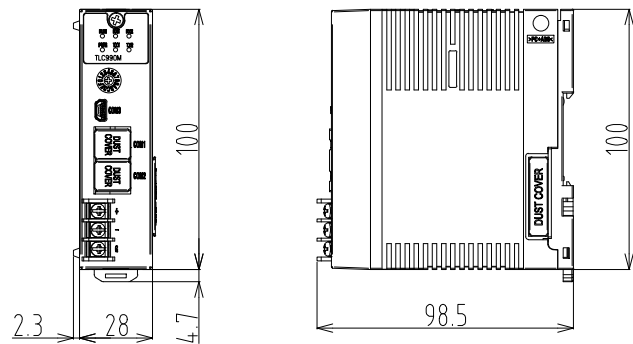

TLC990C -NORMAL TYPE

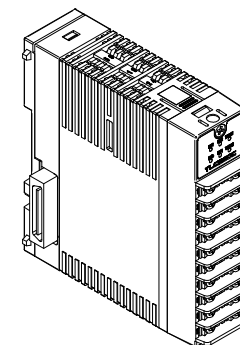
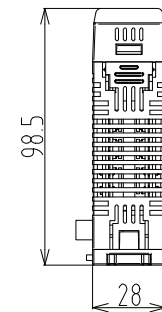
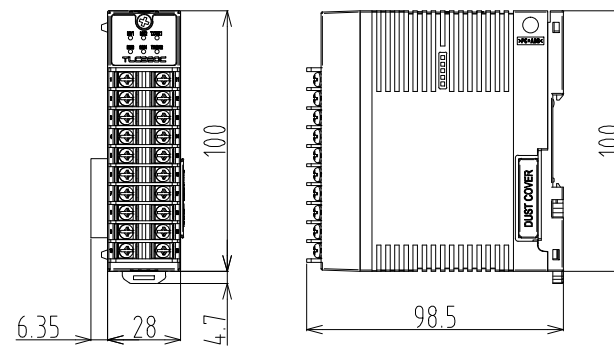

일반적인 경우의 설치

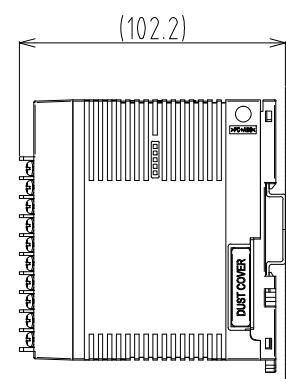
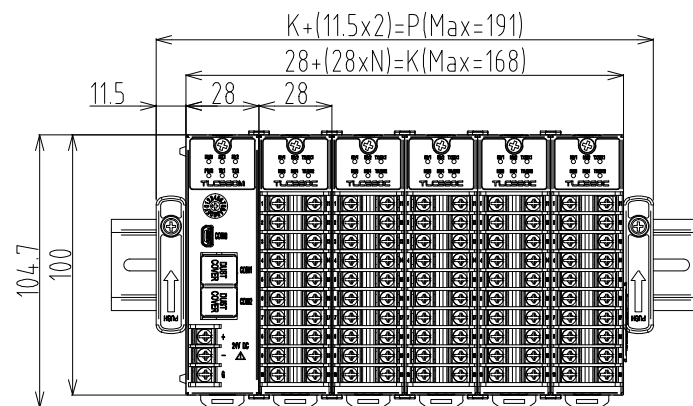

TLC990C -LEFT TYPE

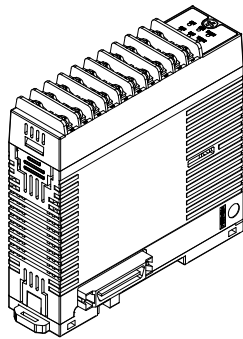
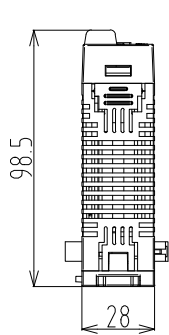
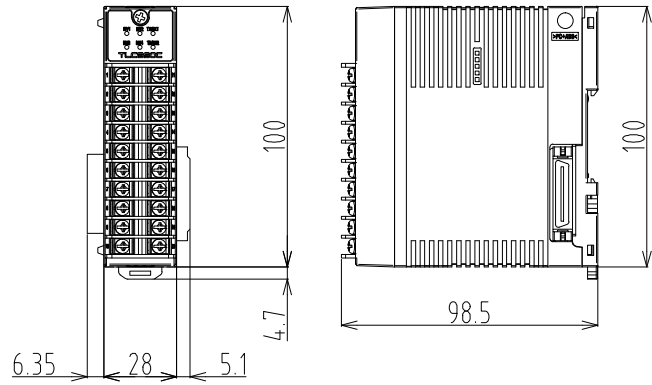

TLC990C -RIGHT TYPE

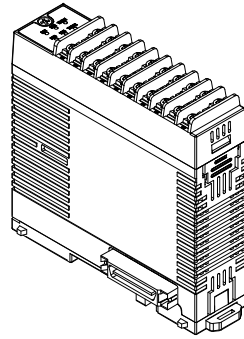
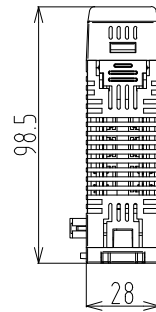
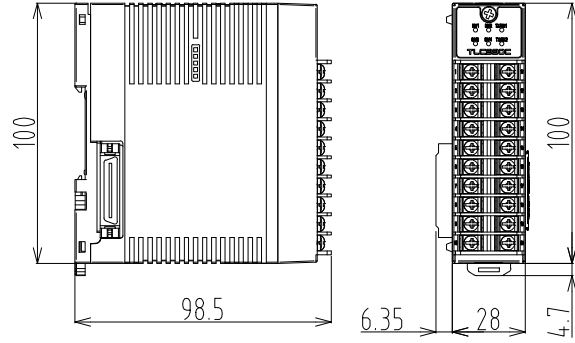

협소공간에서 케이블을 이용한 설치

